

CyberPower®

User's Manual for CyberShield

CS24C12V2-E

CyberShield Battery Backup Power Supplies are designed to provide a local power solution for cable telephony, wireless local loop (WLL), and fiber to the home (FTTH) broadband equipment.

IMPORTANT SAFETY WARNINGS (SAVE THESE INSTRUCTIONS)

This manual contains important instructions regarding the installation and operation of this device. Read this manual thoroughly before attempting to unpack, install or operate this device.

CAUTION! The battery can energize hazardous live parts inside even when the AC input power is disconnected.

CAUTION! To reduce the risk of electric shock, do not remove the cover, except to service the battery. No user serviceable parts inside, except for the battery.

CAUTION! To avoid electric shock, turn off the unit and unplug it from the AC power source before servicing the battery or installing a computer component.

ENCLOSURE INSTALLATION

Carefully follow these instructions during installation of this device:

- 1.) Carry out the installation in a safe area that is free of excessive dust and has adequate airflow.
- 2.) Screws must be appropriate for total weight of the Battery Backup Power Supply and the mounting surface material.
- 3.) Do not operate the Battery Backup Power Supply where the temperature and humidity are outside the specified limits. (Refer to specifications in this manual.)

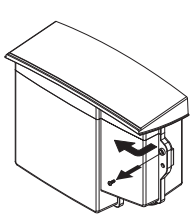

Step 1:
a. Remove the case screw.
b. Open the battery cover.

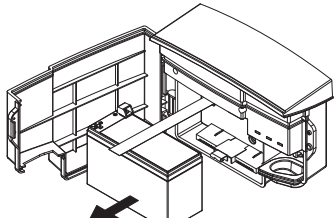

Step 2:
a. Unstrap strap from battery.
b. Slide battery off of the shelf.
c. Disconnect battery cable connector at the chassis end.

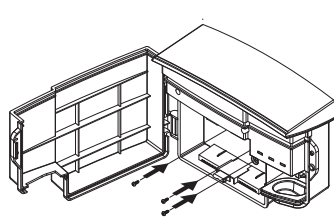

Step 3:
a. Use the enclosed installation template to mark an installation location for the unit.
b. Mount the unit on the wall with 3 mounting screws into the keyhole slots.
c. Tighten the screws to secure the units.
d. Connect the battery connector and replace the battery back.

Installation Suggestion:

To prevent the unit from intrusion of foreign matter, we suggest that the unit should be mounted on a piece of wood which should then be attached to a wall underneath eaves.

Power Cable Selection:

A power cable (4.5m max.) being identified as 18AWG, "OUTDOOR" or "WATERPROOF" should be selected while necessary.

BATTERY REPLACEMENT

This battery is hot-swappable. As long as utility power is on, you may leave the Battery Backup Power Supply and connected equipment on while replacing a new battery.

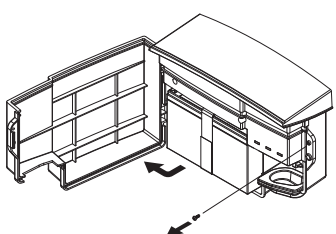

Step 1:
a. Remove the case screw.
b. Open the battery cover.

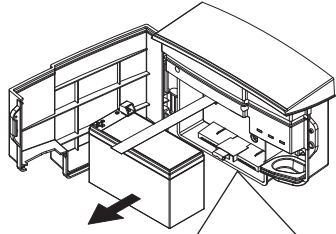

Step 2:
a. Loosen the battery strap.
b. Disconnect battery cable connector to remove battery.
c. Replace with new battery and re-connect the battery connector.

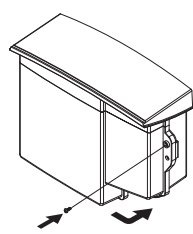

Step 3:
a. Tighten the battery strap
b. Close the battery cover and lock the case screw.

OPERATION

Connect: Equipment and Power

- Step1. Plug the Battery Backup Power Supply power cord into the utility power cord inlet
- Step2. Plug the Battery Backup Power Supply power cord into the wall outlet.



The Battery Backup Power Supply battery charges when it is connected to utility power. The battery charges fully during the first **24 hours** of normal operation. Do not expect full battery run capability during this initial charge period.

COLD START

The cold start feature is for applying power to the Battery Backup Power Supply and connected equipment when the Battery Backup Power Supply is off and there is no utility power. Before using the cold start feature, please make sure the battery is charged. To enable the cold start feature, press the recessed cold start button with a small pointed object.



Once the battery is disconnected, the connected equipment is not protected from power outages.



Pb

Deliver spent batteries to a recycling facility or ship to the manufacturer in the replacement battery packing material.

WARNING INDICATOR

Indicator	Color	Condition
	Green	Battery Backup Power Supply is on utility power.
	Yellow	Battery Backup Power Supply is on battery power.
	Green	DC output power is provided by the battery or utility power.
	Red	The battery is not connected or the battery needs to be replaced.

• Front Panel

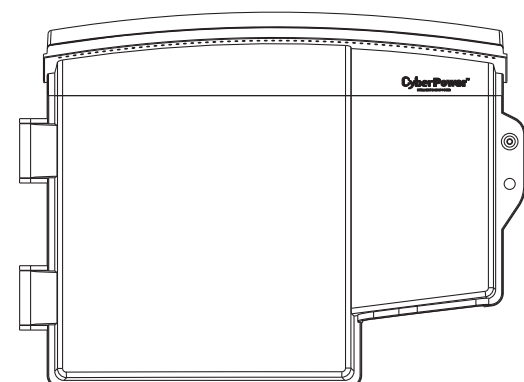

CS24C12V2-E

● Back Panel

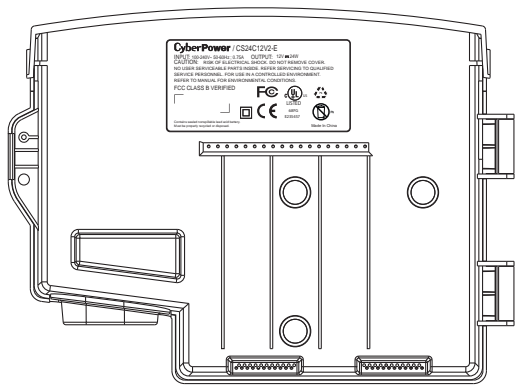

CS24C12V2-E

COMMUNICATION SIGNALS

The communication signals of this unit are isolated from the internal circuitry via open collector opto-coupled transistors. The connection "SIG RTN" (Signal Return) is a common return point for all communication signals. In the typical application, the attached equipment digital ground connects to Signal Return, and pull-up resistors turn the open collector signals into logic levels.

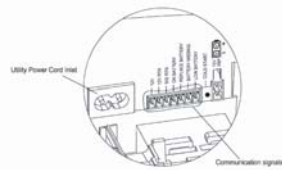

CS24C12V2-E

CS24C12V2-E	Message
12V	+ Voltage output
12V RTN	- Voltage output
SIG RTN	Signal return
ON BATTERY	Low when operating from utility line. Open when operating from battery.
REPLACE BATTERY	Low when battery is charged. Open when battery fails the Self Test.
BATTERY MISSING	Low when battery is present. Open when battery is missing.
LOW BATTERY	Low when battery is near full charge capacity. Open when operating from a battery with < 20% capacity.

SPECIFICATION

Model	CS24C12V2-E
Input	
Voltage Range	100Vac - 240Vac (Universal Input)
Frequency Range	50 - 60 Hz
Output	
On Battery Output Voltage	12Vdc
Continuous Power Capability	24W
Output Power Max	24W
Efficiency (at 75% Max Load)	> 75 %
Battery	
Battery Type	Sealed, Maintenance Free Lead-Acid Battery
Numbers of Battery	7.2AH / 12V x 1
Typical Recharge Time	18Hours
Replaceable	Yes
Surge Protection and Filtering	
Lightning / Surge Protection	Yes
Warning Diagnostics	
Indicators	AC, Output, Battery
Management	
Auto-Charge	Yes
Communication Interface	On Battery, Replace Battery, Battery Missing, Low Battery
Physical	
Maximum Dimensions (L*W*D)	27.5cm x 20.4cm x 9.9cm
Weight (kg)	3.51
Environment	
Operating Temperature	5°F - 122°F (-15°C - 50°C)
Operating Humidity	0 - 95% noncondensing within enclosure
Max Operating Elevation	10,000ft (3,000m)
Max Storage Elevation	50,000ft (15,000m)
Storage Temperature	5°F - 122°F (-15°C - 50°C)

LIMITED WARRANTY

CyberPower warrants to you, the Initial Purchaser, that the Product will be free from defects in material and workmanship for three years from the date of original purchase, subject to the terms of this Limited Warranty. This Limited Warranty gives you specific rights, and you may have other rights, which vary from State to State or Province to Province.

Any Implied Warranty of Merchantability or for Fitness for a Particular Purpose, if applicable to the Product, is limited in duration to three years. This provision shall NOT create any Implied Warranty or Merchantability or of Fitness for a Particular Purpose that would not otherwise apply to the Product. NOTE: **Some States and Provinces do not allow limitations on how long an implied warranty lasts, so the above limitation may not apply to you.**

To be covered you must still be the owner of the Product at the time of the failure that results in the claim made under this Limited Warranty. Your sole and exclusive remedies are those provided by this Limited Warranty. This exclusion of other express warranties applies to written and oral express warranties. CyberPower excludes any liability for personal injury. CyberPower excludes any liability for direct, indirect, special, incidental, or consequential damages, whether for damage to or loss of property, loss of profits, business interruption, information or data. This exclusion applies even though damage or loss is caused by negligence or other fault. NOTE: Some States or Provinces do not allow the exclusion or limitation of incidental or consequential damages, so the above limitation may not apply to you.

DO NOT USE FOR MEDICAL OR LIFE SUPPORT EQUIPMENT OR OTHER HIGH RISK ACTIVITIES. CyberPower does not sell the PRODUCT for use in high-risk activities. The PRODUCT is not designed or intended for use in hazardous environments requiring fail-safe performance, including the operation of nuclear facilities, aircraft navigation or communication systems, air traffic control, weapons systems, life support or medical applications or for use in any circumstance in which the failure of the PRODUCT could lead directly to death, personal injury, or severe physical or property damage, or that would affect operation or safety of any medical or life support device (collectively, "High Risk Activities"). CyberPower expressly disclaims any express or implied warranty of fitness for High Risk Activities. CyberPower does not authorize use of any PRODUCT in any High Risk activities. ANY SUCH USE IS IMPROPER AND IS A MISUSE OF A CYBERPOWER PRODUCT.

The Limited Warranty is governed by the laws of the United States and the State of Minnesota, without reference to conflict of law principles. The application of the United Nations Convention of Contracts for the International Sale of Goods is expressly excluded

FCC NOTICE:

This equipment has been tested and found to comply with the limits for a Class B digital device, pursuant to part 15 of the FCC Rules. These limits are designed to provide reasonable protection against harmful interference in a residential installation. This equipment generates, uses and can radiate radio frequency energy and, if not installed and used in accordance with these instructions, may cause harmful interference to radio communications. However, there is no guarantee that interference will not occur in a particular installation. If this equipment does cause harmful interference to radio or television reception, which can be determined by turning the equipment off and on, the user is encouraged to try to correct the interference by one or more of the following measures: (1) Reorient or relocate the receiving antenna. (2) Increase the separation between the equipment and receiver. (3) Connect the equipment into an outlet on a circuit different from that to which the receiver is connected. (4) Consult the dealer or an experienced radio/TV technician for help.

CAUTION: Shielded signal cables must be used with this device to ensure compliance with Class B FCC limits.
CAUTION: Any changes or modifications not expressly approved by Cyber Power could void the authority granted by the FCC to operate this equipment.

For more information, please contact:
 CyberPower Systems (USA), Inc. 4241 12th Avenue East, Suite 400, Shakopee, MN55379 Phone: (952)403-9500 Fax: (952)403-0009 www.cpsww.com
 CyberPower Systems (EUROPE), Inc. Flight Forum 3545, 5657DW Eindhoven, The Netherlands E-mail: sales@cyberpower-eu.com eu.cyberpowersystems.com

